



QUICK-STEP®
FLOOR DESIGNERS



Parquet

COLLECTION 2017 - 2018

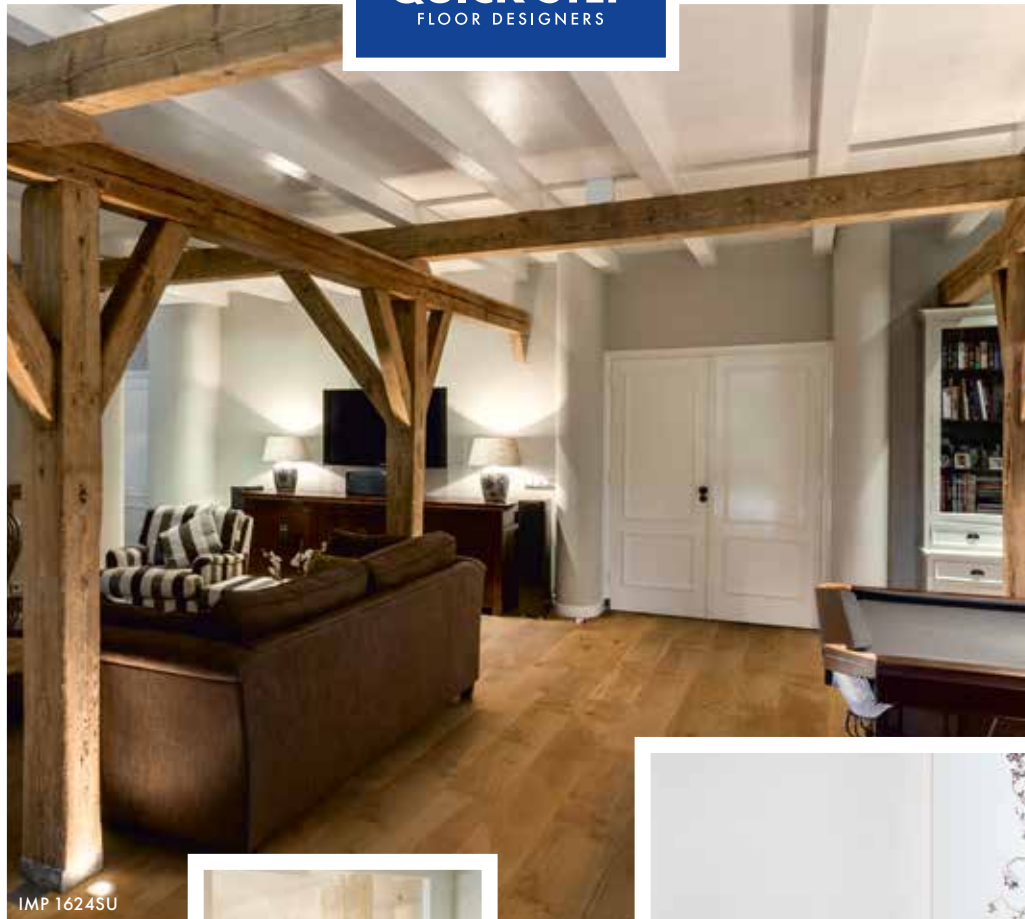

IMP 1624SU



PAL 1473SU



CAS 1478SU

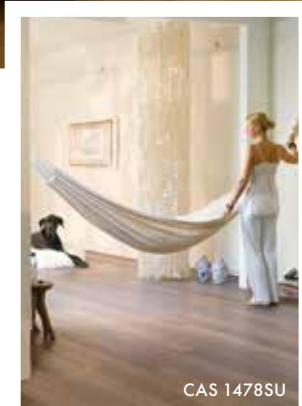

CAS 1478SU



CAS 3487SU



IMP 1623SU

Discover your parquet floor

- 04 Discover our passion for wood
- 06 Authentic beauty meets easy living
- 08 Authentic beauty that lasts a lifetime
- 10 Create your own living space
- 12 Let us guide you to the perfect floor

Collection overview

- 14 Range overview planks
- 16 Types of grading, treatment and finishing
- 18 Discover the full Parquet collection

Installation

- 22 Install your floor without hassle
- 23 Simply choose click or glue
- 24 A Quick•Step® underlay for every situation
- 25 How to install your floor?

Finishing

- 26 Finish perfectly

Cleaning

- 30 Keep your floor in top condition

Discover our passion for...



nature

All our floors are PEFC certified, this indicates that the wood comes from sustainably managed forests.

natural knots

Some of our floors have knots that are only partially filled, others have knots that are sanded by hand. All this is done to emphasize the liveliness of the wood.

artisan characteristics

Saw cuts are tangible evidence of pure artisanal craftsmanship. The manually applied saw cuts vary both in depth, width and interspace. Not a single plank is identical!

craftsmanship

Some of our planks consists of multiple small boards and is composed by hand, with eye for details.

details

Our reclaimed look shows sawcuts, height differences and gaps.

design

We aim for the perfect balance between the type of wood, the grading, the colour, structure, finishing and plank size.

authenticity

By using different treatment techniques such as fuming and special staining, each plank has a unique colour. Because of this, we create a lively colour variation between the planks. These effects bring the authentic character of nature into your home.

perfect finishing

Some of our floors look as matt as untreated wood. Nevertheless, they are easy to maintain.

wooden structures

We brush some of our floors to accentuate the natural grain of the wood and create an extra authentic feel.

Authentic beauty meets easy living



Maximum pleasure, easy maintenance



The highly advanced finishes in lacquer or oil make your floor highly wear, stain and scratch resistant. This Protect+ feature guarantees a long-lasting beauty and quality you can enjoy for many years to come.

Beauty that never fades

You can rely completely on our maintenance products to preserve your floor's beauty. Discover them on page 30 - 31.

Quick-Step Parquet, the beauty of nature



Welcome the beauty of nature into your home by choosing a 100% real wood parquet floor from Quick-Step. The different dimensions of the planks and their wide variety of natural colours and finishes blend perfectly with every style and interior. We pay extra attention to the knots, the grain and colour of the planks so you get to enjoy the warmth of a handcrafted wooden floor.



A perfectly installed floor is just a few clicks away

A parquet floor that's easy to install? Quick-Step makes it possible. Whether you decide to do it yourself or have it done by a professional, your new floor can be installed in no time, thanks to the Uniclic® system. The system enables you to click the planks together, using two different methods. Take a look at page 25 and learn more about this revolutionary installation system.

Another great advantage: there's no need for post-installation work. No sanding, no dust, no varnishing, oiling or painting. As soon as your Quick-Step Parquet floor is installed, it's yours to enjoy for years to come.



How to install your parquet floor

Installing a Quick-Step Parquet floor is very easy. Don't believe it? Let us help you out with our installation videos at bit.ly/ytquickstep



Authentic beauty that lasts a lifetime

As diverse as Quick-Step Parquet floors may be, they all have one thing in common. They withstand time and only grow in natural beauty thanks to the Protect+ feature. On top of that, they are very easy to maintain.



Sliding chairs, high heels, dirty shoes,... your floor gets put to the test on a daily basis. That's why Quick-Step's Parquet floors are coated with high-quality finishes in lacquer or oil. They can be slightly glossy or retain the typical matt look of untreated wood, but with significantly higher wear, stain and scratch resistance in either case.

Moreover thanks to the Uniclic® clicks system with pretension, liquids will not penetrate your floor. Have you spilled something? Just wipe it up with a moist cloth.



What's more, a Quick-Step Parquet floor is very easy to keep looking just like new. With the right products, it will stay beautiful and last even longer. Discover our entire range on page 14 - 15.



Create your own living space

More inspiration on www.quick-step.com

A beautiful interior starts with a good foundation. The floor could be considered as the fifth wall and therefore it should not be overlooked. Whatever your style, whatever your room, Quick-Step has the right floor: from light, clean floors to warm brown classics and even reclaimed floors with knots and cracks. We will help you to find your perfect floor!



Our extra matt lacquer finish combines the look of an untreated floor with the advantages of a lacquered floor. It is easy to clean and its maximum protection against scratches and stains keeps your floor in shape!

Let us guide you to the perfect floor

Choosing a new floor can raise a lot of questions: which colour should I go for? Which floor matches my style and my interior? Check out our FloorExplorer and RoomViewer online – we will help you make up your mind.



FLOOR EXPLORER

3 EASY STEPS TO FIND YOUR PERFECT FLOOR

With so many flooring options to choose from, making the right decision can be a challenge. That's why we have introduced the online FloorExplorer tool: in three simple steps, you will get a selection of floors that perfectly match your personal needs and style.

Why not give it a try?
Enter the FloorExplorer at
www.quick-step.com

1 SELECT A ROOM



2 CHOOSE A COLOUR

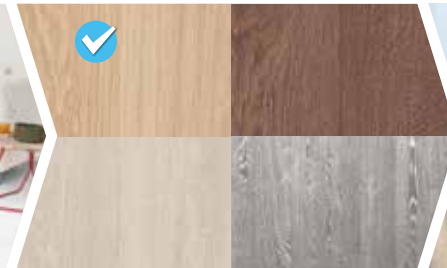

3 DEFINE YOUR STYLE



ROOM VIEWER

GET A PREVIEW OF YOUR FAVOURITE FLOORS

Wouldn't it be great if you could try out several floors first before making a final decision? Or even preview them in your own interior? With the online RoomViewer tool, you can do just that. Get lifelike previews and make sure that your final decision is the right one.

Try it out now!
Launch the RoomViewer at
www.quick-step.com



DISCOVER YOUR PERFECT FLOOR ON WWW.QUICK-STEP.COM

Range overview planks

	dimensions	thickness	bevels	build-up	pack	warranty
<i>Imperio</i>	 220 x 22 cm	≡ 14 mm		 13,2 mm SPRUCE	4 x  = 1,936 m ²	 LIFETIME WARRANTY DOMESTIC USE
<i>Palazzo</i>	 182 x 19 cm	≡ 14 mm		 13,2 mm SPRUCE	6 x  = 2,075 m ²	 LIFETIME WARRANTY DOMESTIC USE
<i>Castello</i>	 182 x 14,5 cm	≡ 14 mm		 13,2 mm SPRUCE	6 x  = 1,583 m ²	 LIFETIME WARRANTY DOMESTIC USE
<i>Villa</i> 3-strip	 220 x 19 cm	≡ 14 mm	o	 13,2 mm SPRUCE	6 x  = 2,508 m ²	 LIFETIME WARRANTY DOMESTIC USE

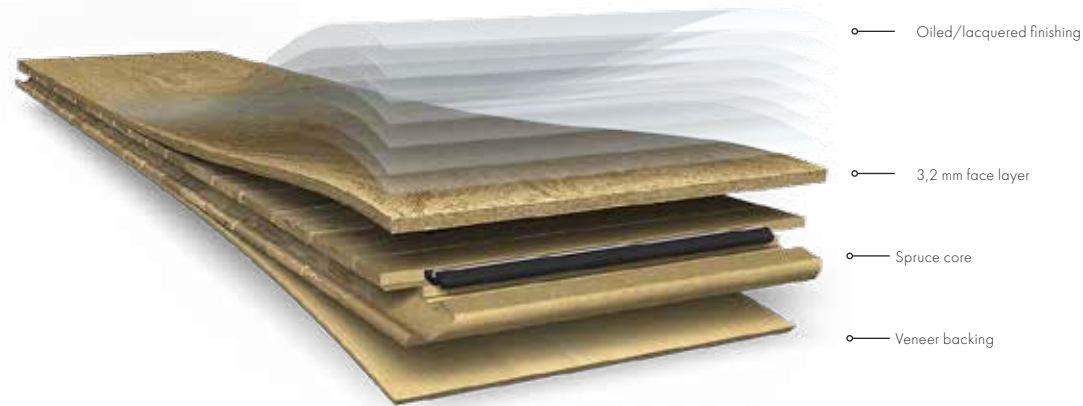

Did you know that Quick-Step Parquet floors are **F4 Star compliant**?
This means that we do not add formaldehyde to our products.

Every pack can contain 1 board which is composed of two planks with variable length.



The detail makes the difference

Each Parquet floor has its own story and a unique look and feel. The Quick-Step designers carefully select the grading, structure and finishing in line with the character of each floor design.

Wood species



Oak

Oak has a yellow to brown colour, with its typical grain.



Iroko

Iroko planks have a golden colour, with brown straight grain.



Walnut

Walnut has a warm brown colour which contrasts with the whitish sapwood.



Merbau

Merbau varies widely from orange towards dark reddish brown.

Grading

We have a unique grading system that sorts our floors into three different categories. It gives you an idea of how your floor will look.



Nature

Wood with small knots. Variation in colour and structure.



Marquant

Wood with knots. Lively variation in colour and structure.



Vibrant

Wood with large knots and cracks. Lively variation in colour and structure with a rustic appearance.

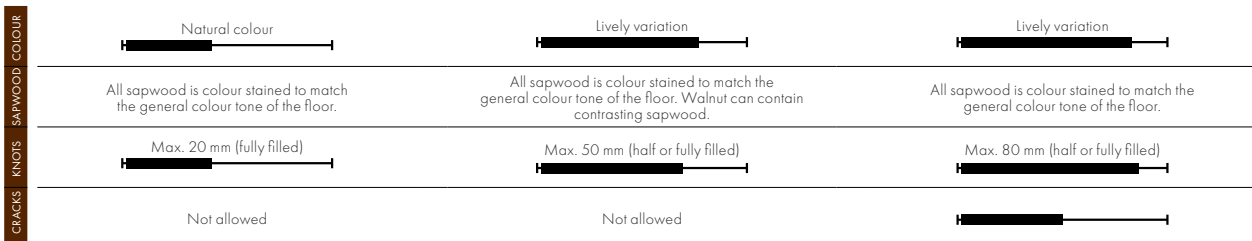

Treatment



Brushed **Deep Brushed**

Brushing accentuates the natural grain structure of the wood plank and adds depth.



Natural knots

On some floors the knots are not fully filled. Some of them are even manually sanded to emphasize the liveliness of the wood.



Design colours

By using different treatment techniques such as fuming and staining, each plank has a unique colour.

Finishing

All Quick-Step Parquet floors are prefinished in the factory, which means no oiling or lacquering is needed after installation.

1 Oiled

Oiled finish



2 Lacquered

Extra matt finish

Matt finish

Satin finish

Bright finish

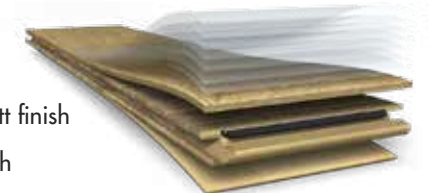

- 2 layers of high quality oil.
- Brings out the authenticity of real wood.
- Can be renewed and repaired with Quick-Step maintenance products.

- 7 layers of protective lacquer.
- Highly scratch and wear resistant. Protects against water and household chemicals.
- Easy to clean wooden floor.

Extra matt finish NEW

The extra matt lacquer finish combines the look of an untreated floor with the advantages of a lacquered floor.



Bring authenticity to your home

Discover our range of 100% real wood parquet floors

IMP 1623SU

Imperio IMP 220 x 22 cm ≡ 14 mm

Long and wide oak planks



PURE OAK MATT
IMP1623SU
MARQUANT



NATURAL HERITAGE OAK OILED
IMP1624SU
MARQUANT

Palazzo PAL 182 x 19 cm ≡ 14 mm

Elegant oak planks



SNOW WHITE OAK EXTRA MATT
PAL3884SU
NATURE



DUNE WHITE OAK OILED
PAL1473SU
NATURE



HONEY OAK OILED
PAL1472SU
NATURE



NATURAL MYSTIC OAK MATT
PAL1336SU
NATURE

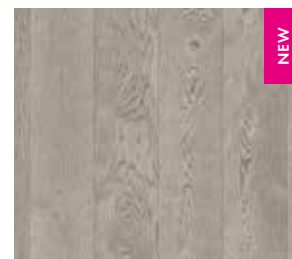

CONCRETE OAK OILED
PAL3795SU
VIBRANT

Castello **CAS**
182 x 14,5 cm ≡ 14 mm

Smaller planks in different finishes



POLAR OAK MATT
CAS1340SU
NATURE



PURE OAK MATT
CAS1341SU
NATURE



LUSTER OAK EXTRA MATT
CAS4011SU
MARQUANT



MERBAU BRIGHT
CAS3488SU
NATURE



IROKO BRIGHT
CAS3487SU
NATURE



CAPPUCCINO OAK OILED
CAS1478SU
MARQUANT



NOBLE WALNUT SATIN
CAS1356
NATURE



SWEET WALNUT SATIN
CAS3444SU
MARQUANT

Villa **VIL**
220 x 19 cm ≡ 14 mm

Long planks with a 3-strip design



SUGAR OAK MATT
VIL1749SU
NATURE



MERBAU BRIGHT
VIL3488SU*
NATURE

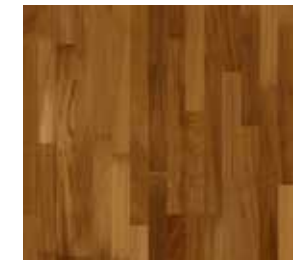

IROKO BRIGHT
VIL3487SU
NATURE



GINGER BROWN WALNUT BRIGHT
VIL4010SU
MARQUANT



Too many options to choose from?

Not sure which floor is your absolute favourite? The RoomViewer helps you make your choice. Try out your options on www.quick-step.com.

* All countries are MTO

STEP 1 INSTALLATION

Install your floor without hassle!

Laying a Quick-Step floor is so easy thanks to the patented world-famous Uniclic® click system. This system is highly user-friendly, quicker to install and a lot more solid than other systems. A Quick-Step floor makes installation easy, even in the tightest corners or under radiators and doors.

1 Install your floor anywhere, even on floor heating

Quick-Step Parquet floors are perfect for installing over floor heating, whether you choose for a glued down or floating installation.

2 Installation tools for every situation

Quick-Step accessories such as our installation set or hand saw help make your floor installation easy.

UNICLIC®
PATENTED TECHNOLOGY



Discover our installation videos on www.quick-step.com



Simply choose click or glue

Whether you opt for a glued down or a floating installation, Quick-Step has the perfect solution.

GLUED DOWN

Why Quick-Step® Parquet Glue?

1 Maximum sound reduction

Reflected walking sound in the room is reduced to a minimum.

2 Resistant to humidity

The Quick-Step Parquet Glue has a good resistance to humidity.

3 Highly elastic

The Quick-Step Parquet Glue is highly elastic. Your floor can breathe and expand with any temperature variation.

4 Ideal for floor heating

Gluing your floor is the best solution for floor heating systems.



**Quick-Step®
PARQUET GLUE**
16kg: QSWG16 = for +/- 16 m²
use 1-1,2 kg per square metre engineered wood



**Quick-Step®
PARQUET TROWEL**
QSWB11
The Parquet glue trowel ensures the perfect glue consumption per m². To be ordered separately.

FLOATING

Why a Quick-Step® underlay?

1 Permanently sound-absorbing

Quick-Step underlays maintain their initial thickness over the years. You may rest assured that they will continue to dampen sounds both in the room in which they're installed and in the room below.

2 Ideal for Uniclic®

All Quick-Step underlays offer a stable base which protects the Uniclic® system against heavy furniture and heavy short term loads such as high heels.

3 Levels out irregularities

A Quick-Step underlay creates a firm, level base for your new floor.

4 Excellent damp protection

The integrated Damp Proof Membrane (DPM) protects your floor from rising damp.













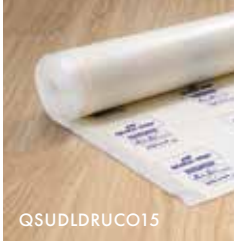





Floor heating: Every Quick-Step Parquet floor is suitable for installation over traditional floor heating. Keep in mind:

- The best result will be obtained when gluing your Parquet floor with Quick-Step Parquet Glue.
- As a damp-resistant screen cannot be used in combination with a glued down wood floor, sudden or large temperature changes might cause condensation.
- For floating installations, we only advise floor heating in combination with the Quick-Step Silent Walk underlay. This underlay stops rising damp or condensation.



A Quick-Step® underlay for every situation

An underlay is an absolute necessity when laying a floor. Installing the right underlay has a major impact on the final look, quality and comfort of your Quick-Step Parquet floor. The high-quality underlays are easy to install, create a level base for your new floor and provide excellent acoustic and thermal insulation. The Quick-Step underlays offer a stable base protecting the Uniclic® systems. Moreover, they ensure protection from rising damp.

I want a budget friendly solution	I want to reduce both transition as reflected sound	I want to reduce the reflected sound that is caused by walking on the floor	I want to reduce the sound heard by neighbours	I need additional insulation and leveling for my floor
↓	↓	↓	↓	↓
Quick-Step® BASIC PLUS	Quick-Step® UNISOUND	Quick-Step® SILENT WALK	Quick-Step® TRANSISOUND	Quick-Step® THERMOLEVEL
				
QSUDLBP15/60	QSUDLDRUCO15	QSUDLSW7	QSUDLTRS15	QSUDLTL9
A good and economical basis for places with less traffic, for instance a bedroom or attic.	Ideal for places with frequent traffic, for instance a living room.	Ideal for the ground floor. Suitable for underfloor heating and cooling.	I want to reduce the sound heard by neighbours.	The perfect choice for the installation on top of an existing tile floor or highly uneven floor. Also provides extra insulation.
Thickness: 2 mm Roll: 15 m ² / 60 m ²	Thickness: 2 mm Roll: 15 m ²	Thickness: 2 mm Roll: 7 m ²	Thickness: 2 mm Roll: 15 m ²	Thickness: 5mm Box: 9m ²
 	 	   	 	 
✓ Damp protection ✓ Leveling effect	✓ Damp protection ✓ Leveling effect	✓ Damp protection ✓ Leveling effect ✓ Floor heating ✓ Floor cooling	✓ Damp protection ✓ Leveling effect	✓ Damp protection ✓ Leveling effect
💡 Use this underlay in combination with tape: NETAPE50				

Please note: It is important to use a Quick-Step underlay or Quick-Step Parquet glue to preserve the quality of your floor. When installed and maintained in the right way, Quick-Step can offer a warranty on the Quick-Step floor and Uniclic® system. Ask your dealer for a genuine Quick-Step underlay or Quick-Step Parquet glue and visit www.quick-step.com to read our warranty conditions.

How to install your floor?



1 Angling

To install the first row of planks.

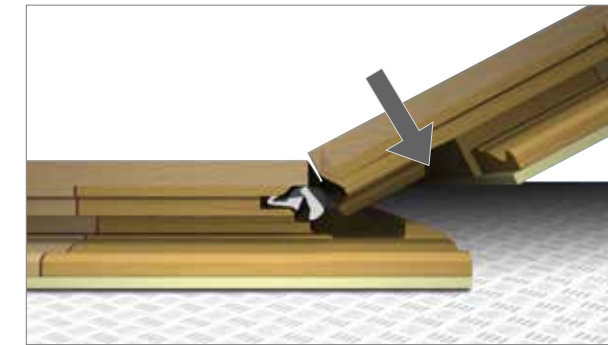

Click the panels first on the short side and click the long sides together.

2 Horizontal insertion

To install in difficult areas.

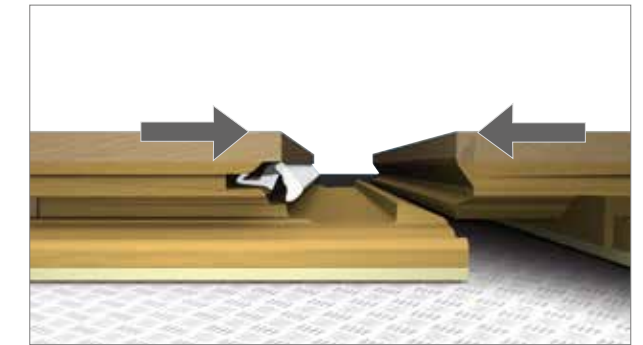

Unlike many other brands, Quick-Step Parquet planks can also be inserted horizontally. This is very handy when installing the last row of planks, or in places where it is difficult or even impossible to tilt them (under door frames or radiators, for example).

Installation tools



Quick-Step® INSTALLATION SET QSTOOL

Contents: Quick-Step tapping block, metal crowbar, adjustable spacers.



Install your parquet floor in an easy and professional way with the handy Quick-Step installation set.

Quick-Step® HAND SAW QSTOOLSAW



With the help of the Quick-Step hand saw floors can be fitted perfectly underneath door frames.

STEP 2 FINISHING

Finish perfectly

Finish your floor perfectly with the Quick-Step skirtings and profiles.

1 Matching colours

Quick-Step offers skirting boards with perfectly matching colours for every floor.



2 Real veneer

Quick-Step skirting boards are finished with a quality veneer surface. This means they can really take the rough and tumble of everyday life!

3 Quick-Step® warranty

Quick-Step skirting boards come with the same warranty as Quick-Step floors.



Easy to install



QSTRACK



QSG LUE290



Quick-Step®
TRACK
240 cm x 0,8 cm x 2,7 cm

Our made-to-measure track allows you to install skirting boards quick and easily. Simply attach the track to the wall with screws or Quick-Step One4All glue and then just click the skirting boards onto it. Afterwards, they can be easily removed, which is ideal when you need access to cables.



Quick-Step®
ONE4ALL GLUE
Contents: 290 ml

The skirting boards and profiles can be installed swiftly and securely with the Quick-Step One4All glue.

With one tube of One4All glue you can fix approximately 15 m of skirtings to a wall.

Skirting boards

Quick-Step®
PARQUET SKIRTING BOARD
240 x 1,6 x 8 cm



QSWPPSKR(-)

Skirting board with a groove on the back to hide phone or computer cables.

Paintable skirting boards



The paintable skirting boards with Incizo® technology are very easily cut to fit the desired height (thanks to the preapplied cuts). Once they are fitted, you can paint them or just leave them white.

Quick-Step®
OVOLO SKIRTING BOARD
240 x 1,6 x 16 cm



QSISKRWHITE

Quick-Step®
OGEE SKIRTING BOARD
240 x 1,6 x 16 cm

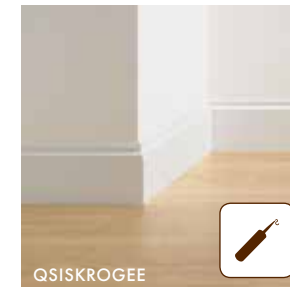

QSISKROGEE

Quick-Step®
COVER SKIRTING BOARD
240 x 1,6 x 12,9 cm



QSISKRCOVER

Quick-Step®
FLEXIBELE SKIRTING
1,4 cm x 4 cm (to be cut to the desired length)



QSFLEXSKR
QSPSKR4PAINT

Also available in a non-flexible version to finish your room in the same style (length 240 cm: QSPSKR4PAINT).



Finishing profiles for floor and stairs

Quick-Step's Incizo® profile is a multifunctional finishing tool. One and the same profile can be used for all the finishes of your floor and stairs, in the matching colour. Simply cut the Incizo® basic profile to the shape required using the supplied slitler.

Quick-Step® Incizo®: five questions, one answer



1 How can I join two floors of the same height?

2 How can I solve variations in height from one floor to another?

3 How do I finish my floor along a wall or a window?

4 How can I connect my floor to a carpet, and have a beautiful finish?

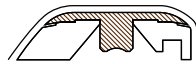

Use the Incizo® profile cut as an expansion profile.

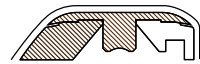

Use the Incizo® profile cut as an adapter profile.

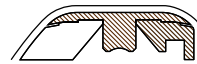

Use the Incizo® profile cut as an end profile.

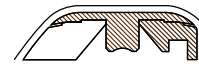

Use the Incizo® profile cut as a transition profile.



5 What about the finishing of my stairs?

You can cover your stairs or steps with Quick-Step planks and finish in the style of your choice with the Incizo® profile as a stair nose.



Quick-Step®
INCIZO® PROFILE

QSWINCP(-)
215 cm x 5,4 cm x 1,7 cm
Contents: 1 Incizo®, 1 slitler, 1 plastic rail, screws and plugs.



Quick-Step®
INCIZO® ALUMINIUM SUB-PROFILE FOR STAIRS

NEWINCPBASE(-)
215 cm x 1,9 cm x 7,35 cm
To be ordered separately.
The Incizo® stairs finishing cannot be used for commercial applications.



Finishing tools

Quick-Step®
HYDROKIT
QSKITRANSP 310ml



The Quick-Step Hydrokit is a transparent silicone for an invisible and waterproof finishing of skirting boards, profiles,...

Quick-Step®
KIT
QSKIT(-) 310 ml



This elastic, acrylic-based paste is the ideal solution for those spots where you cannot install skirting boards or profiles. It's available in a colour matching your floor. Ask your dealer for advice.



QSRCINOX15
QSRCINOX22

Quick-Step®
PIPE COVERS

Contents: 2 radiator covers per package
Available in two different diameters - either 15 mm or 22 mm.
The Quick-Step stainless steel pipe covers allow you to finish heating elements and pipes in a stylish and modern way in perfect harmony with your floor.

STEP 3
CLEANING

Keep your floor in top condition



**Quick-Step®
CLEANING KIT**

Contents: mop holder, washable microfiber mop,
Quick-Step Cleaning product 750ml

The cleaning products are specifically developed for Quick-Step floors. They cleanse the floor surface thoroughly and maintain the original look of your floor. No residual layers of cleaning product are left behind.

Also available separately:



**Quick-Step®
CLEANING
PRODUCT 2L**
QSCLEANING2000

**Quick-Step®
CLEANING
PRODUCT 750 ML**
QSCLEANING750

**Quick-Step®
CLEANING
MOP**
QSCLEANINGMOP

EVERY 4TH CLEANING



**Quick-Step®
OIL CARE**
QSCARE750
Contents: 750ml

Keep your floor in top condition

- Protects your oiled Parquet floor and prevents it from drying out and losing its gloss
- Restores the original look and eliminates micro-scratches
- Delays the need for maintenance oil
- Easy, user-friendly and efficient
- Use once every 4 "slightly damp" cleans

EVERY YEAR



**Quick-Step®
MAINTENANCE OIL WHITE**
QSWMAINTOILW

**Quick-Step®
MAINTENANCE OIL
TRANSPARENT**
QSWMAINTOILN
Contents: 1 L (=75 m²)

For intensive care & repair

- Retains the oiled Parquet floor's matte finish
- Repairs minor damages to the floor
- Nourishes the floor
- Low emissions
- Solvent-free



Check our online overview to see which maintenance oil fits your oiled Parquet floor: www.quick-step.com

Oiled Parquet floors: the cleaning cycle



Repair



**Quick-Step®
REPAIR KIT**
QSPREPAIR

Contents: melting knife, cleaning comb,
7 wax blocks, sanding pad

Light damages can easily be repaired in the original colour with the Repair Kit. Simply recreate the colour of your damaged planks with one of the seven wax pieces selected to cover all Quick-Step colours.



Check the specific colour combination for your floor on www.quick-step.com

Parquet

COLLECTION 2017 - 2018



Too many options to choose from?

Not sure which floor is your absolute favourite? The RoomViewer helps you make your choice.

Try out your options on www.quick-step.com

Your Quick•Step® point of sale



www.quick-step.com

FOLLOW US ON



www.facebook.com/QuickStepFloors



www.youtube.com/quickstepfloor



plus.google.com/+quickstep



www.pinterest.com/quickstepfloor



[@QuickStepFloor](https://twitter.com/QuickStepFloor)

Quick•Step® is a quality product produced by **UNILIN** bvba – division Flooring, Ooigemstraat 3, B-8710 Wielsbeke, Belgium, Europe. COVERPHOTO IMP 1623SU. Product images may differ from actual product. The availability of products, or the products themselves, may change at any time without notice.

Content © 2017/2018 by **UNILIN** bvba – division Flooring.

All rights reserved. The contents of this brochure may not be reproduced in whole or in part without prior written permission from the publisher. Print ref. 017 662 01